

## SUTURES, SUCTION TUBES & MEASURING TOOLS

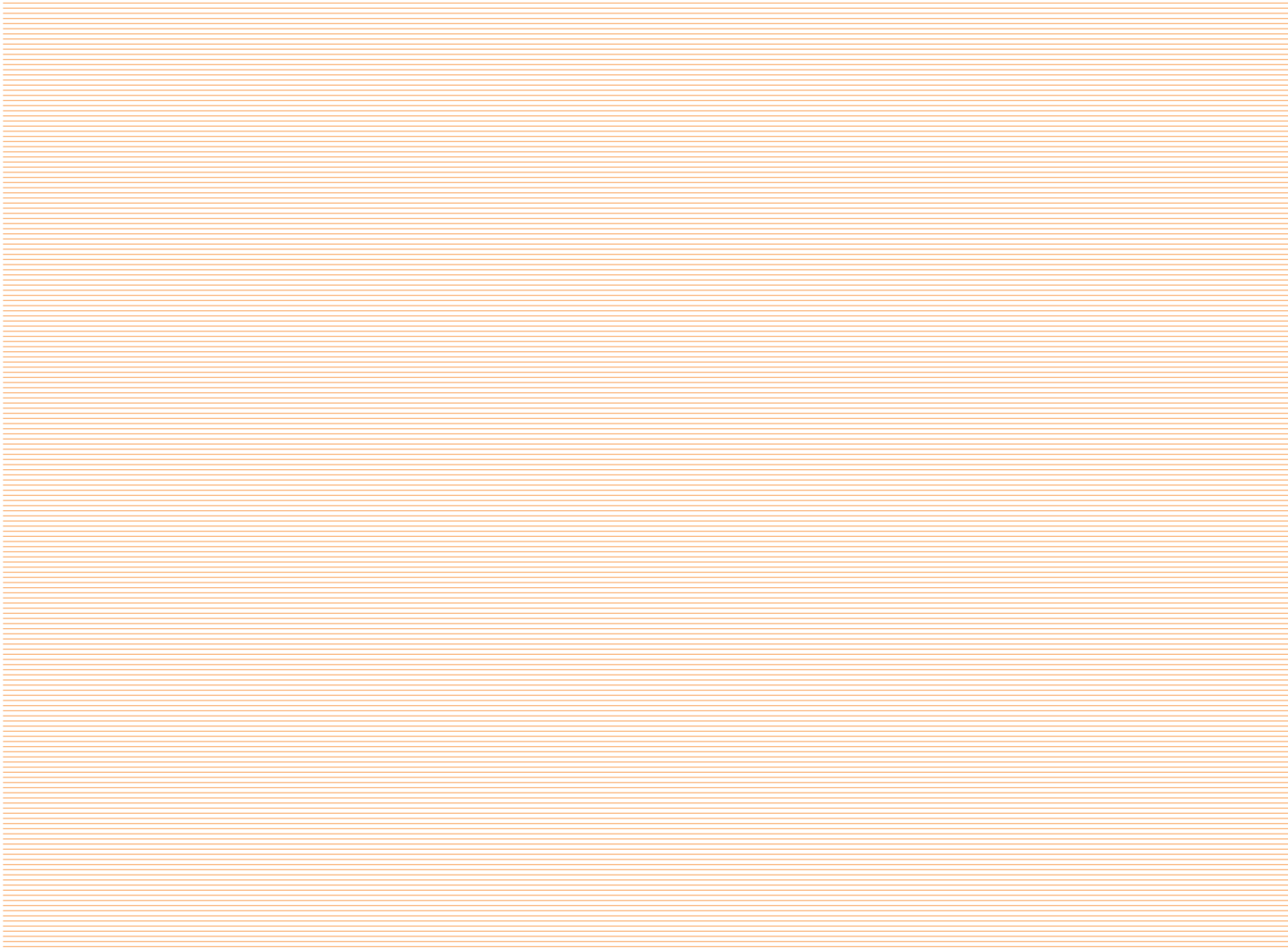

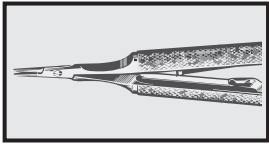

Riverdine Needles



Reverdin

Reverdin

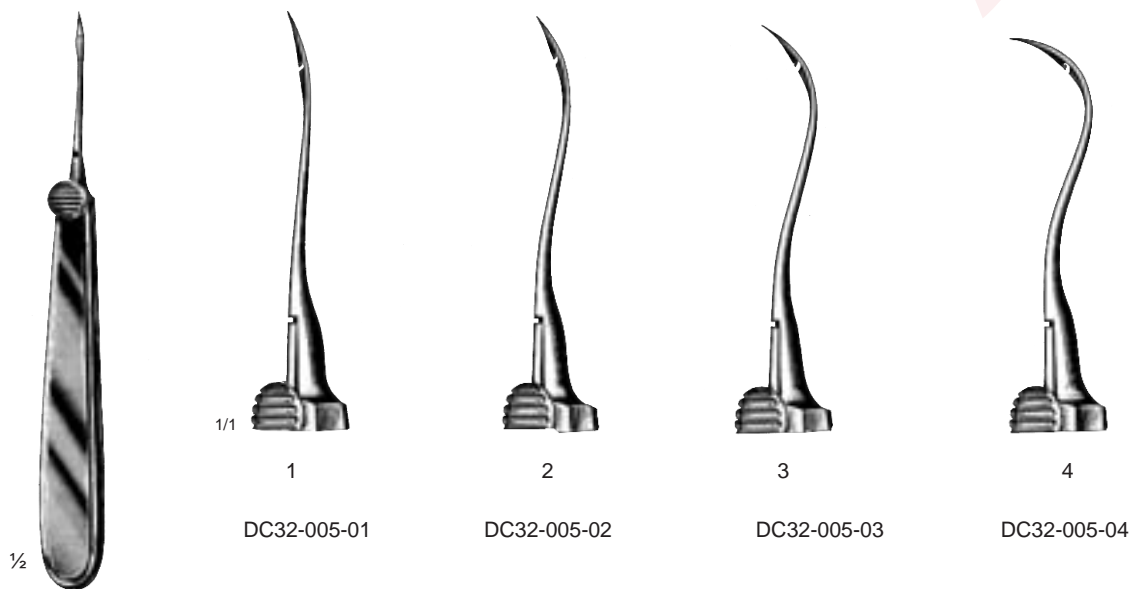

Reverdin  
14 cm / 5<sup>1</sup>/<sub>2</sub>"

Needle Holders

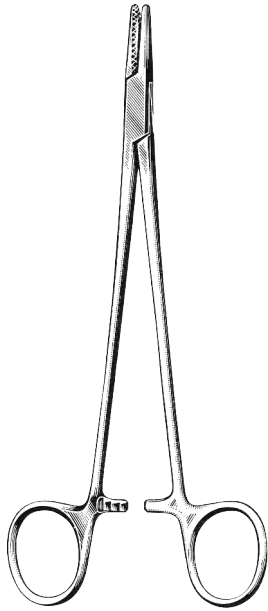
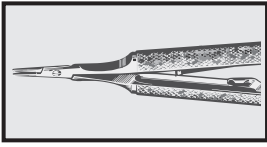

Mayo-Hegar

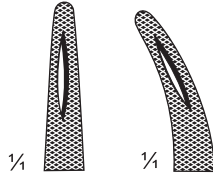

cm	in.	straight	curved
14	5 1/2	DC32-007-14	
16	6 1/4	DC32-007-16	DC32-009-16
18	7	DC32-007-18	DC32-009-18
20	8	DC32-007-20	DC32-009-20
24	9 1/2	DC32-007-24	DC32-009-24
26	10 1/4	DC32-007-26	DC32-009-26
30	12	DC32-007-30	

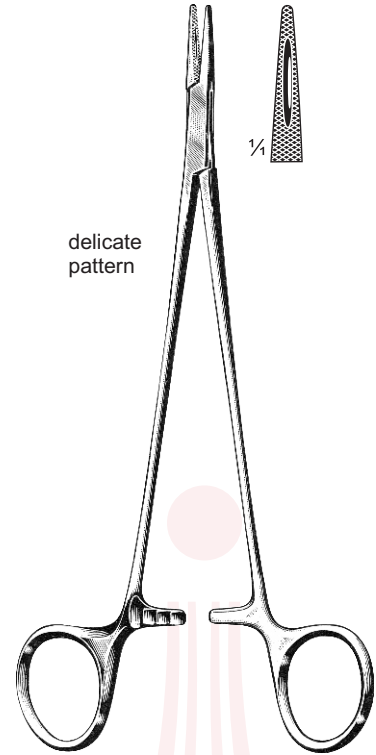

delicate pattern

Mayo-Hegar  
DC32-011-16 = 16cm/6 1/4"  
DC32-011-18 = 18cm/7"  
DC32-011-20 = 30cm/8"

ACMA  
INTERNATIONAL

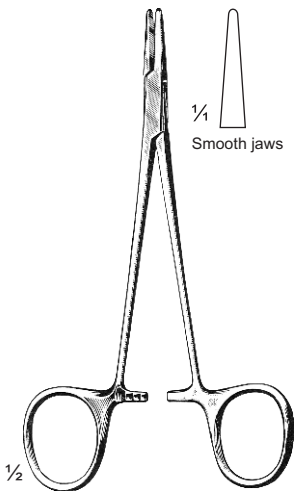

Halsey  
DC32-013-13  
13 cm / 5"

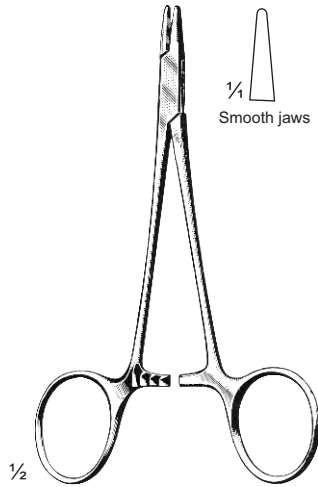

Webster  
DC32-015-13  
13 cm / 5"

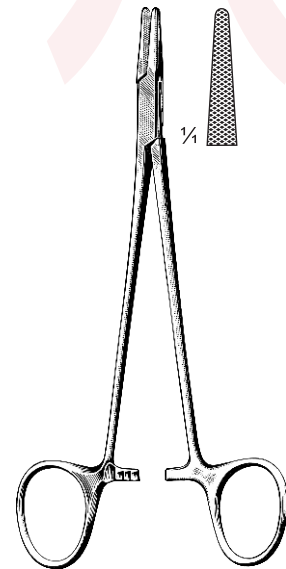

Crile-Murray  
DC32-017-15  
15 cm / 6"

Needle Holders

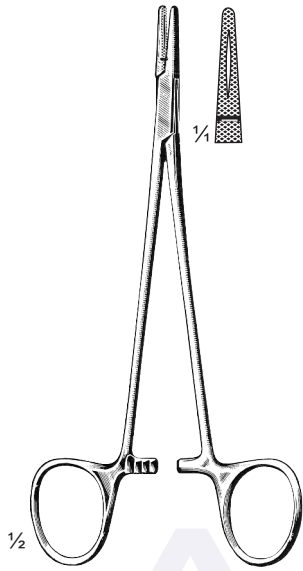
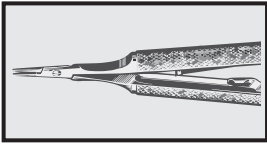

**Crile-Wood**  
DC32-019-15  
15 cm / 6"

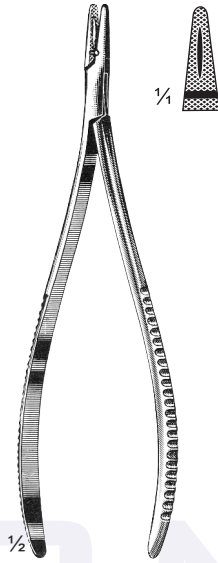

**Crile**  
DC32-021-15  
15 cm / 6"



**Toennis**  
DC32-023-18  
18 cm / 7"

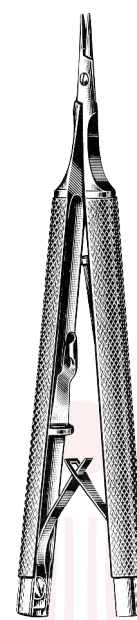

**Castroviejo**

1/4  
DC32-025-13  
13cm/5"  
curved

1/4  
DC32-025-13  
13cm/5"  
straight

ACMA INTERNATIONAL

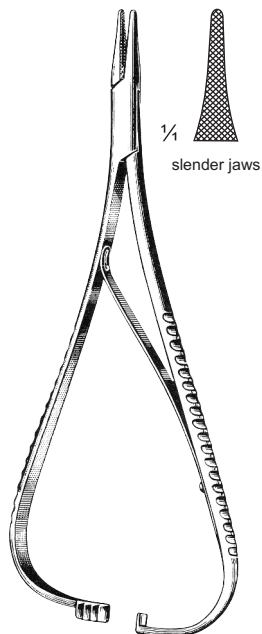

**Mathieu**  
DC32-027-14 = 14 cm / 5 1/2"  
DC32-027-17 = 17 cm / 6 3/4"

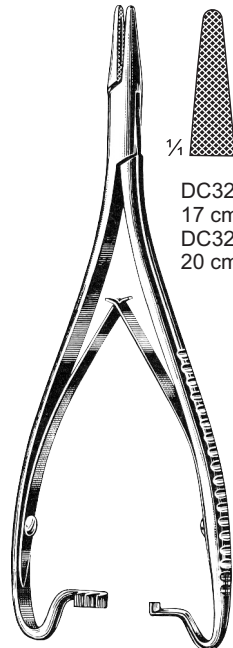

**Mathieu**

1/4  
DC32-029-17  
17 cm / 6 3/4"  
DC32-029-20  
20 cm / 8"

1/4  
DC32-031-17  
17 cm / 6 3/4"  
DC32-031-20  
20 cm / 8"

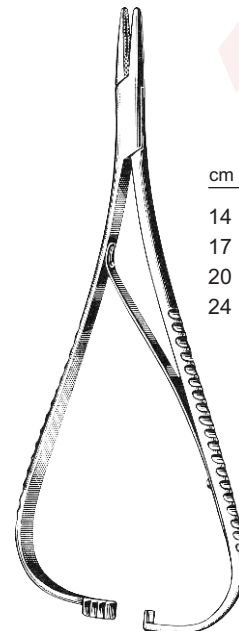

**Mathieu**

cm	in.	D	D
14	5 1/2	DC32-033-14	DC32-035-14
17	6 3/4	DC32-033-17	DC32-035-17
20	7	DC32-033-20	DC32-035-20
24	9 1/2	DC32-033-24	DC32-035-24

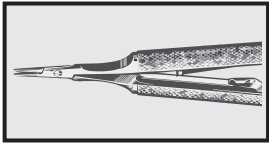

Needle Holders

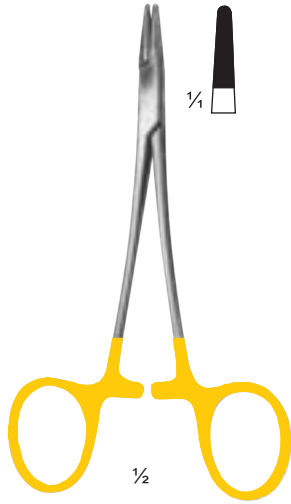

**Webster**  
DC32-037-13  
13cm/5"



**Baumgartner**  
DC32-039-13  
13cm/5"



**Derf (Halsey)**  
DC32-041-12  
12cm/4 3/4"

ACMA  
INTERNATIONAL



1/4  
DC32-043-12  
12cm/4 3/4"

**Derf (Halsey)**



1/4 1/4  
DC32-045-15 DC32-047-18  
15cm/6" 18cm/7"  
smooth jaws

**Crile-Wood**

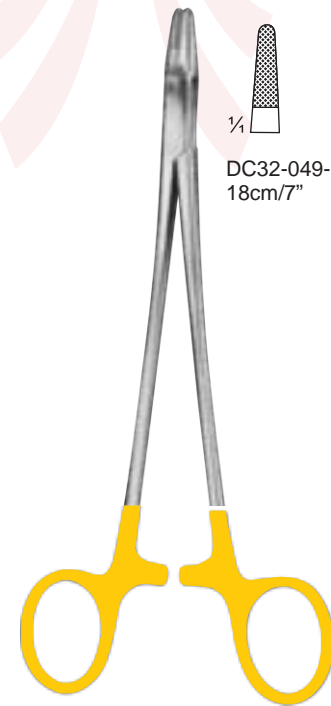

1/4  
DC32-049-18  
18cm/7"

**New Orleans**

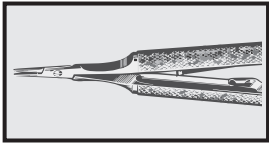

Needle Holders

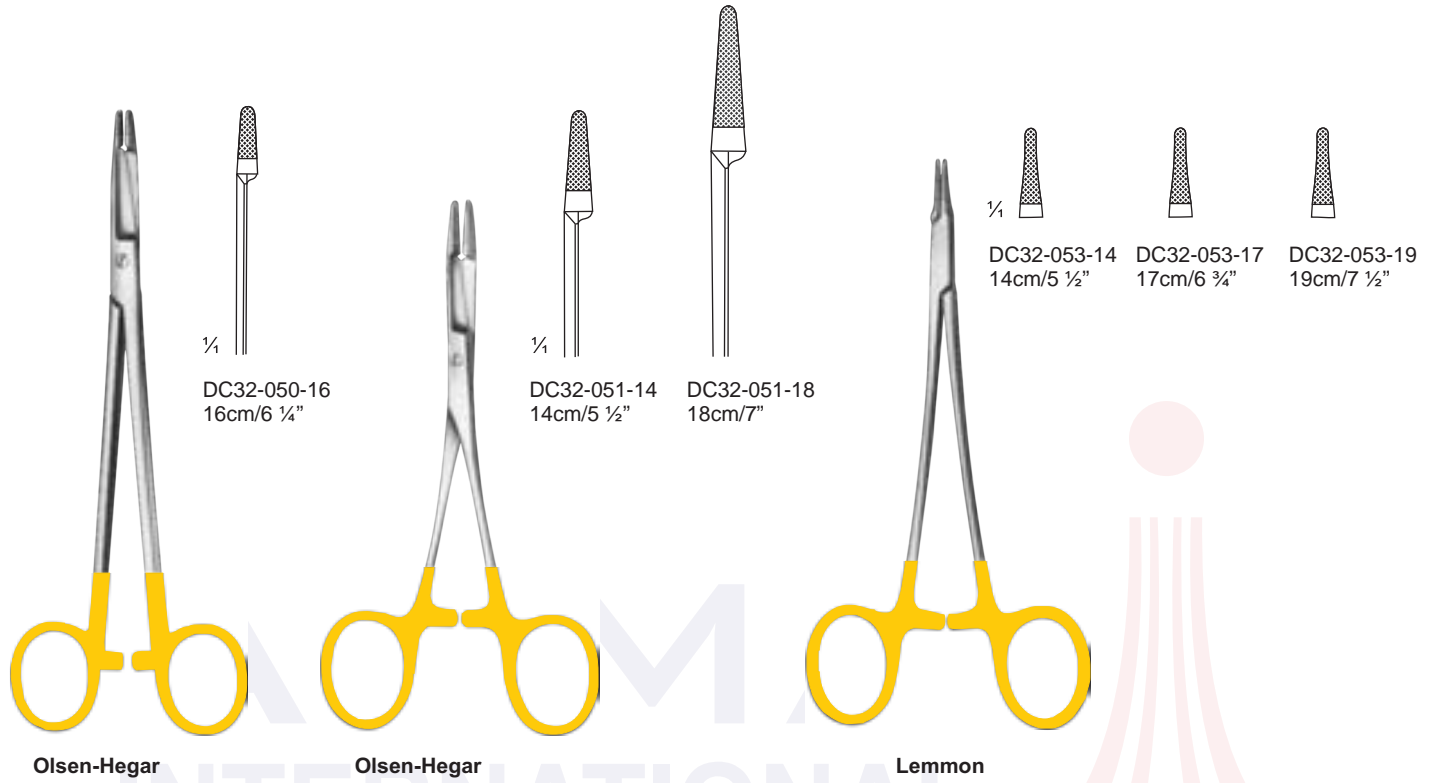

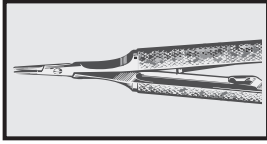

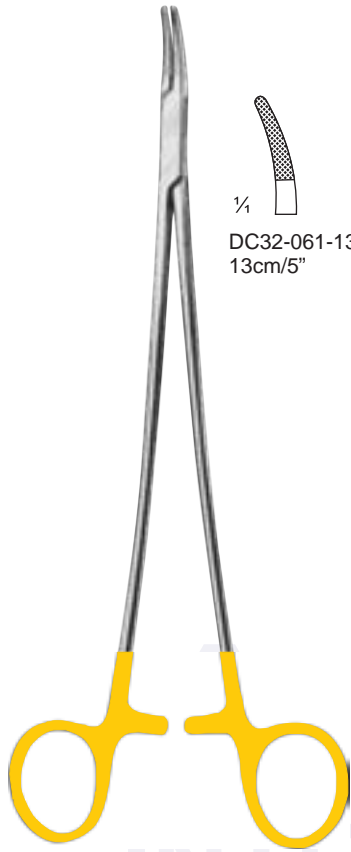

Needle Holders

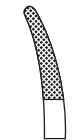

Crile-Wood

- 

DC32-061-13  
13cm/5"
- 

DC32-061-15  
15cm/6"
- 

DC32-061-18  
18cm/7"
- 

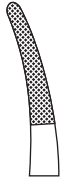
DC32-061-20  
20cm/8"
- 

DC32-061-23  
23cm/9"





Mayo-Hegar

- 

DC32-063-14  
14cm/5 1/2"
- 

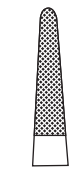
DC32-063-16  
16cm/6 1/4"
- 

DC32-063-18  
18cm/7"
- 

DC32-063-20  
20cm/8"
- 

DC32-063-23  
23cm/9"
- 

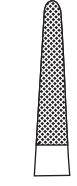
DC32-063-26  
26cm/10 1/4"
- 

DC32-063-30  
30cm/12"

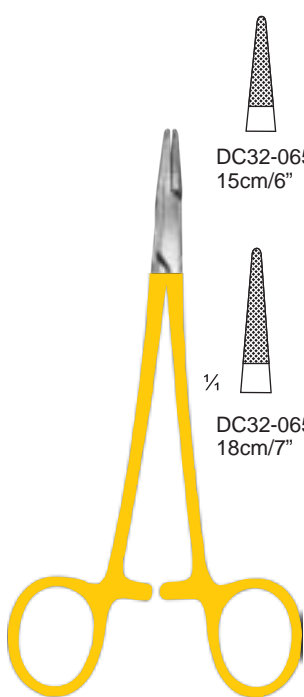

Crile Wood

- 

DC32-065-15  
15cm/6"
- 

DC32-065-18  
18cm/7"

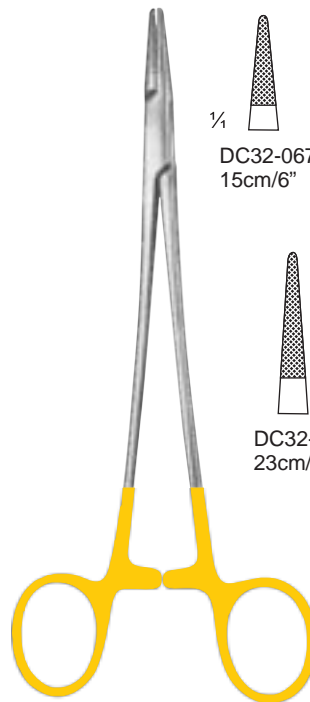



Crile-Wood (Newman)

- 

DC32-067-15  
15cm/6"
- 

DC32-067-18  
18cm/7"
- 

DC32-067-20  
20cm/8"
- 

DC32-067-23  
23cm/9"
- 

DC32-067-26  
26cm/10 1/4"

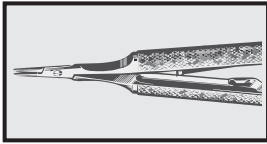

Needle Holders

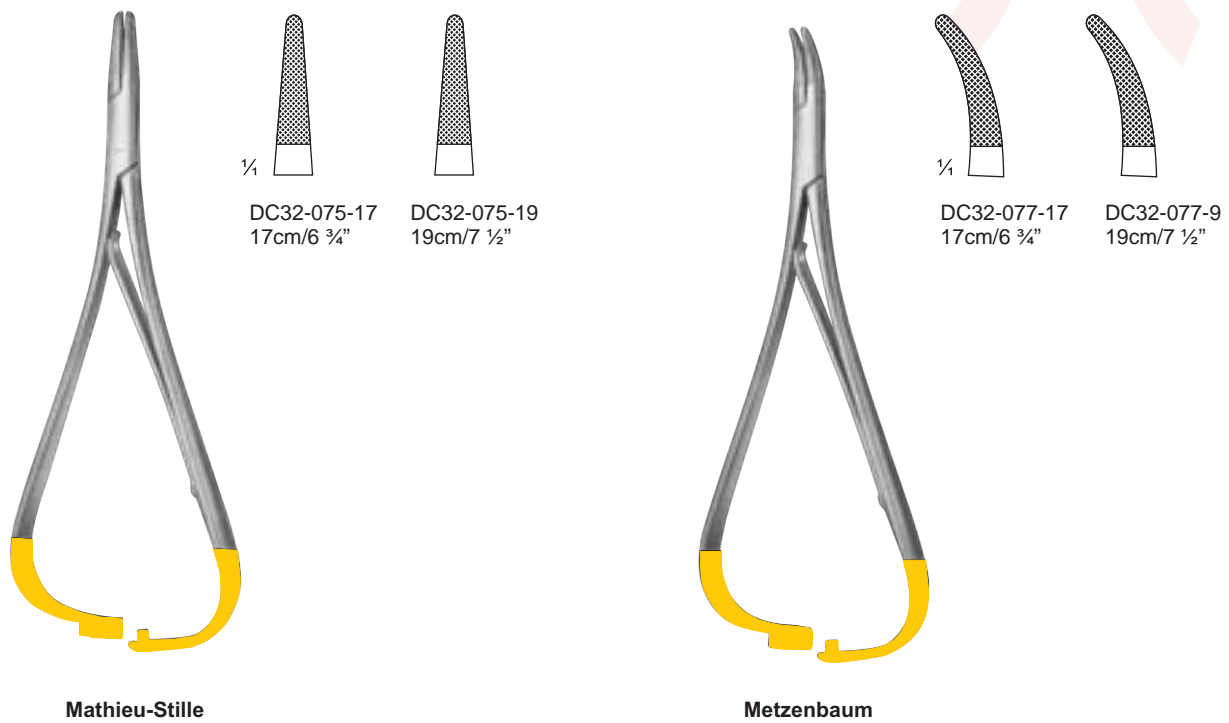
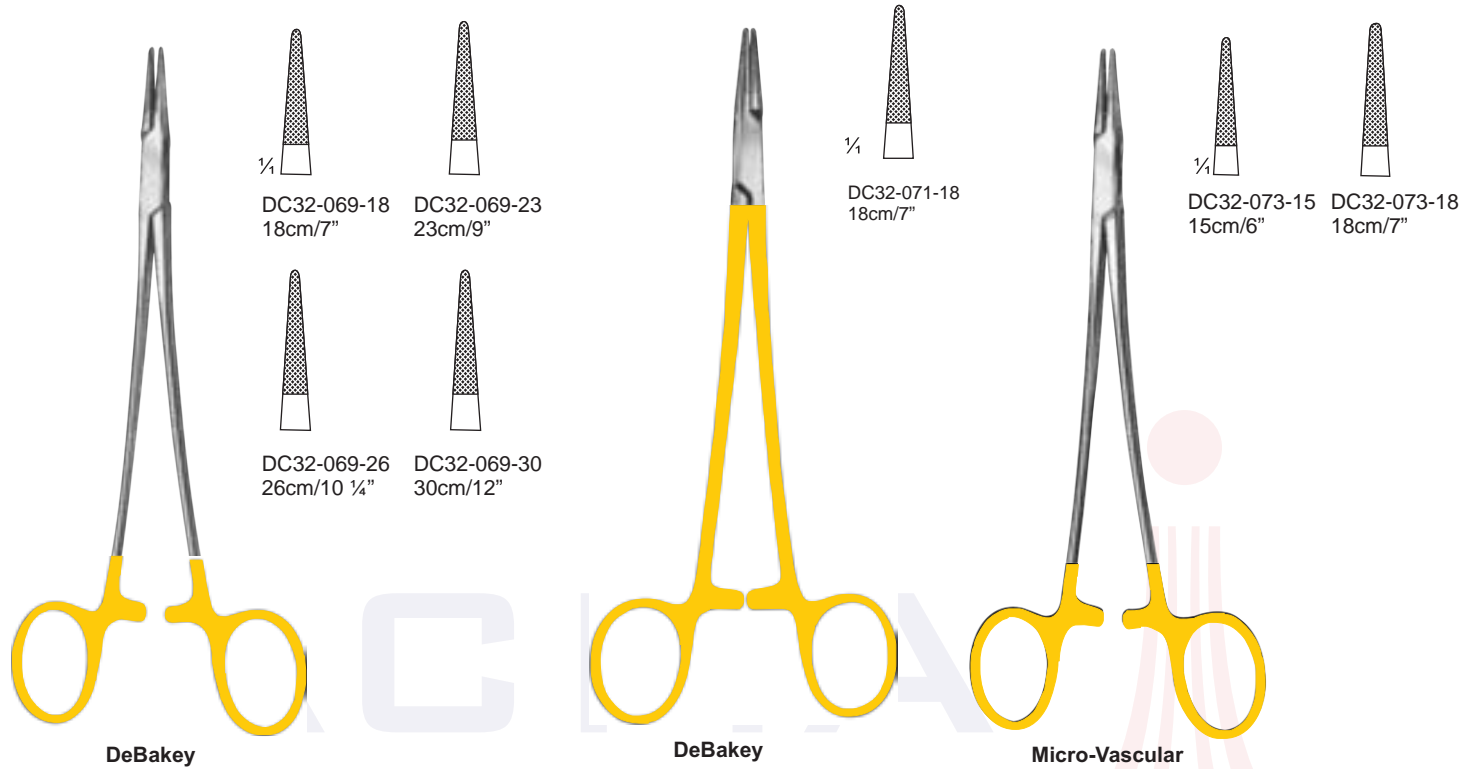



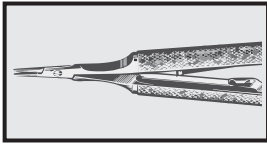

Needle Holders

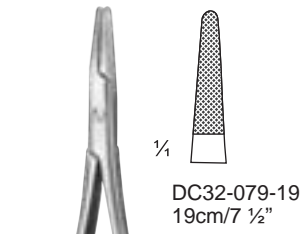

1/2  
**Tönnies**

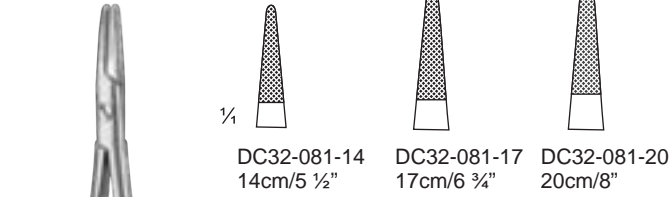

**Lichtenberg**

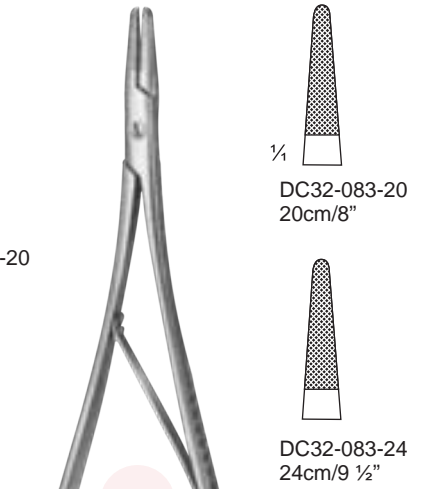

**Mathieu**

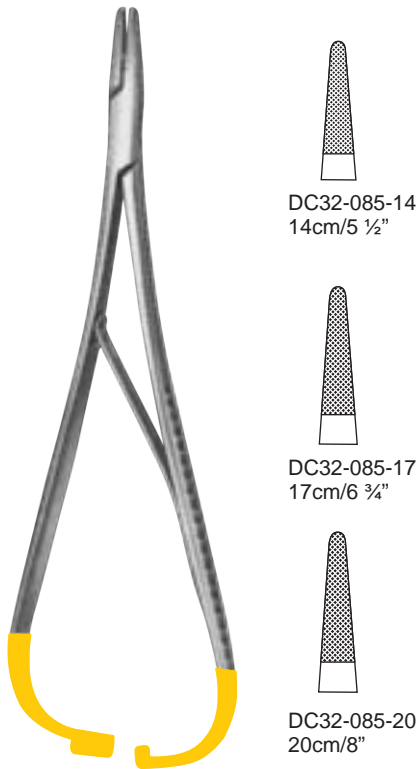

**Mathieu**

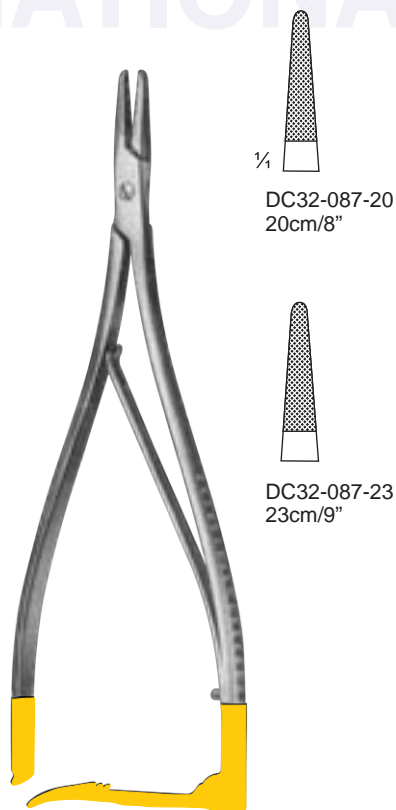



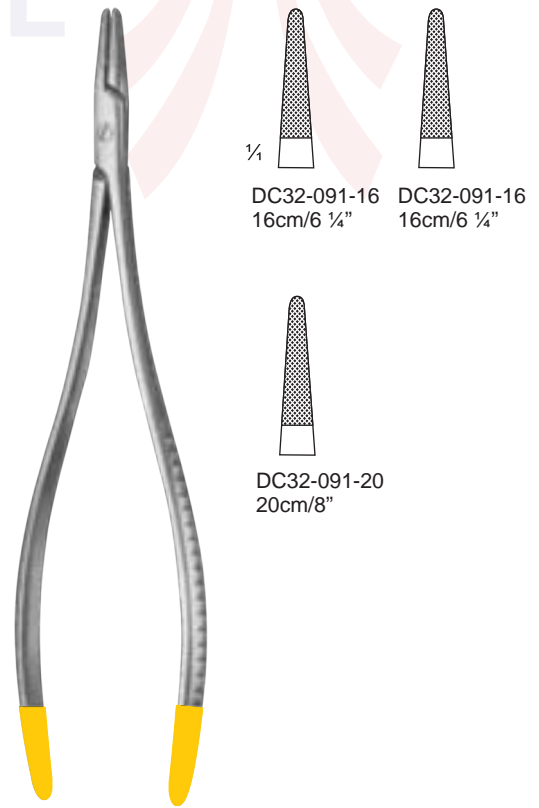

**Zweifel**

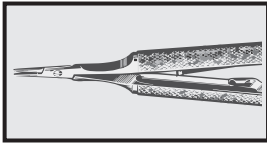

**Langenbeck**

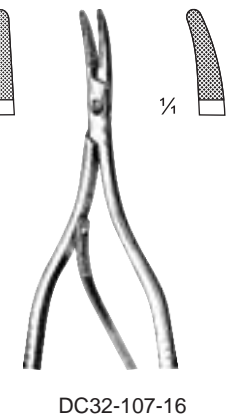

Needle Holders

 <p>1/2 <b>Castroviejo</b></p>	<p>1/4 DC32-093-13 13cm/5" solid serration</p>	<p>1/4 DC32-095-13 13cm/5" solid serration</p>	 <p>1/2 <b>Castroviejo</b></p>	<p>1/4 DC32-101-13 13cm/5" solid serration</p>	 <p>1/2 <b>Arruga</b> DC32-105-16 16 cm/6 1/4"</p>	 <p>1/4 DC32-107-16</p>
	<p>1/4 DC32-097-13 13cm/5" micro fine serration</p>	<p>1/4 DC32-099-13 13cm/5" micro fine serration</p>		<p>1/4 DC32-103-13 13cm/5" micro fine serration</p>		
 <p>1/2 <b>Castroviejo</b></p>	<p>solid serration</p>	<p>1/4 DC32-109-18 18cm/7"</p>	<p>1/4 DC32-111-18 18cm/7"</p>	<p>1/4 DC32-113-20 20cm/8"</p>	<p>1/4 DC32-115-20 20cm/8"</p>	
	<p>micro fine serration</p>	<p>1/4 DC32-117-18 18cm/7"</p>	<p>1/4 DC32-119-18 18cm/7"</p>	<p>1/4 DC32-121-20 20cm/8"</p>	<p>1/4 DC32-123-20 20cm/8"</p>	

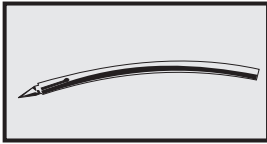

Trocars and Suction Tubes



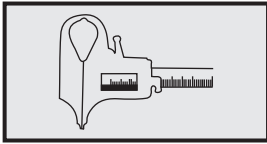

Measuring Tools

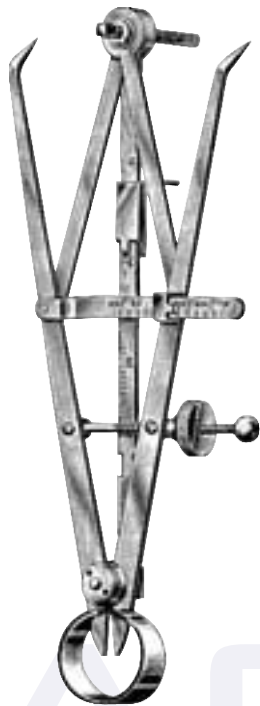

**Korkhaus**  
DC32-137-01



18.5 cm / 7 1/4"  
DC32-139-18

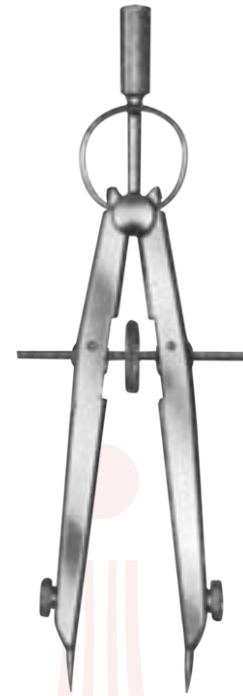

12 cm / 4 3/4"  
DC32-141-12



DC32-143-01

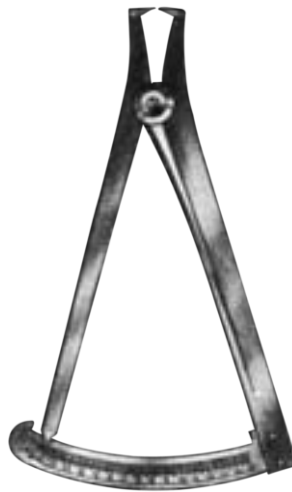

Measuring range 0-15 mm  
DC32-145-15

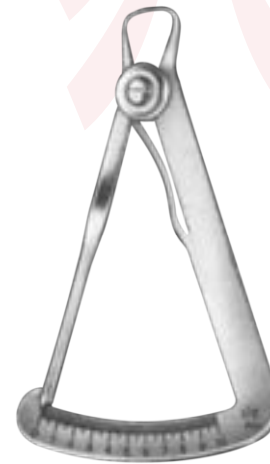

Measuring range 0-10 mm  
DC32-147-10

DC32-137-01	Three dimensional Caliper
DC32-139-18	Bow space for orthodontic work
DC32-141-12	Dividing Compass
DC32-143-01	Bow Compass
DC32-145-15	Decimal spring Caliper
DC32-147-10	Decimal spring Caliper

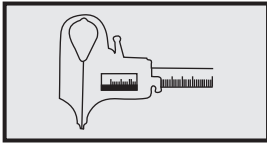

Head Lamps  
Tail Voice  
Caliper

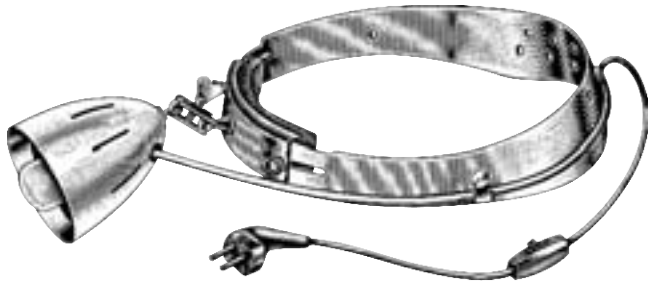

**Orion**  
DC32-149-01

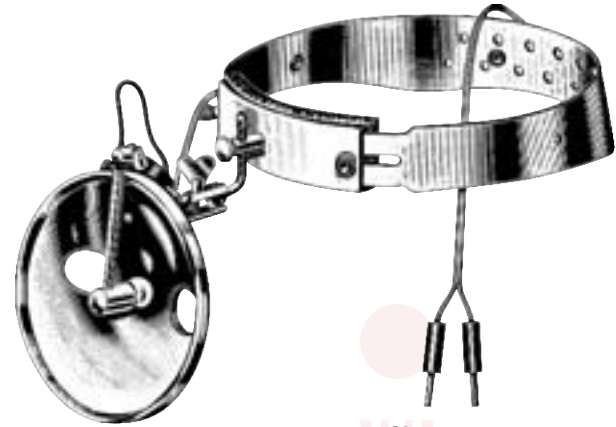

**Clar**  
DC32-151-01

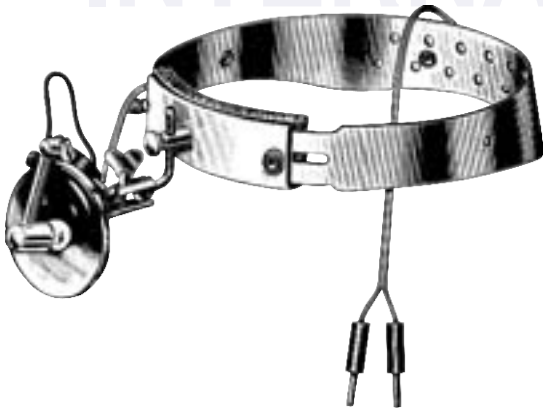

**Clar-mini**  
DC32-153-01



11.5 cm / 4½"  
DC32-155-11



11.5 cm / 4½"  
DC32-157-11



**Boley**  
DC32-159-01

ACMA  
INTERNATIONAL

DC32-149-01	DC32-151-01	Head Lamp
	DC32-153-01	Head Lamp
DC32-155-11	DC32-157-11	Tail Voice
	DC32-159-01	Caliper

ACMA  
INTERNATIONAL

